

Tucker Trimmer Tool Basics

Designed as a trim down ruler for squares that are constructed from triangles, the Tucker Trimmer™ tool helps quilters produce high quality pieces of work. By starting with squares that are slightly larger than necessary, quilters can quickly sew and press units and then trim them down to an exact measurement. Use the chart below to determine your starting size, then construct using Deb's preferred construction methods illustrated here, or using one of your own.

Once the units are constructed, they will be trimmed down to an exact measurement using the Tucker Trimmer™ tool. Note that there are two marks, a circle and a half circle, that will aid in determining which corner of the ruler to use for trimming.

If you will be trimming your squares to a whole number (2", 3", 4", etc.), and if you are right handed, position the whole circle in the upper right. If you are left handed, position the circle in the upper left. If you will be trimming your squares to "half numbers" (1½", 2½", 3½", etc.), rotate the ruler around to position the half circle in the

upper right or upper left respectively. You then simply align the diagonal ruler lines with the diagonal seam lines of the oversized blocks and trim down the first corner. You then rotate the block, aligning not only the diagonal

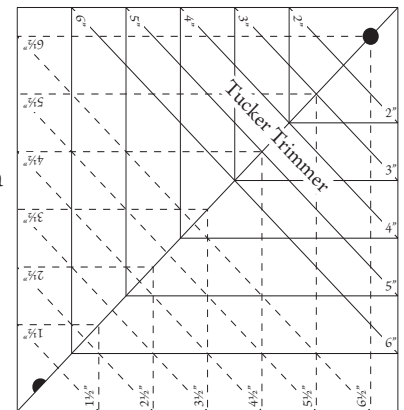

guidelines over the seam lines, but also the horizontal and vertical "clean-up" guidelines over the two sides previously trimmed. Each of your units will be trimmed to the perfect size, and will have every seam going directly into the corners of your blocks.

In addition to the instructions included here, you can also watch video demonstrations for using your Tucker Trimmer™ tool at:

<http://www.youtube.com/user/DebTuckerStudio180>

Starting Square Size Chart

Finished Size of Pieced Unit	1"	1½"	2"	2½"	3"	3½"	4"	4½"	5"	5½"	6"
Cut Size of Pieced Unit	1½"	2"	2½"	3"	3½"	4"	4½"	5"	5½"	6"	6½"
Starter Squares for Half Square Triangles	2"	2½"	3"	3½"	4"	4½"	5"	5½"	6"	6½"	7"
Starter Squares for Combination Units	2½"	3"	3½"	4"	4½"	5"	5½"	6"	6½"	7"	7½"
Starter Squares for Quarter Square Triangles	2½"	3"	3½"	4"	4½"	5"	5½"	6"	6½"	7"	7½"

For Piecing Half Square Triangle Units

Determine either the required finished size or cut size of the unit you wish to make. Refer to chart for the suggested size squares to use for making your units.

Position two squares right sides together.

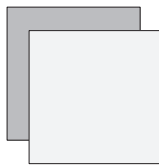

Position

Mark two stitching lines ¼" on either side of a center diagonal line. I use my **Quilter's Magic Wand™** for this task.

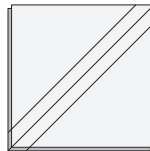

Mark

Stitch on lines, then cut down the middle.

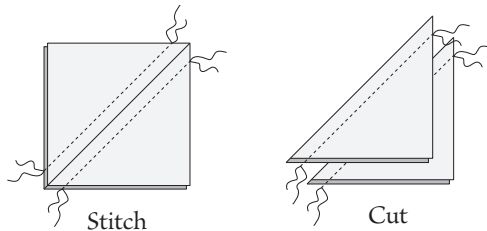

Stitch

Cut

Press seams toward darker fabric.

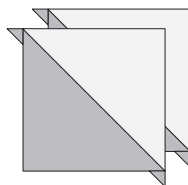

Press

Position the Tucker Trimmer™ over the unit, carefully aligning solid diagonal line with stitched seam as shown. Note that the right handed quilter will trim up the right side and across the top, while the left handed quilter will trim up the left side and across the top.

Trim one corner (two sides) to a clean edge.

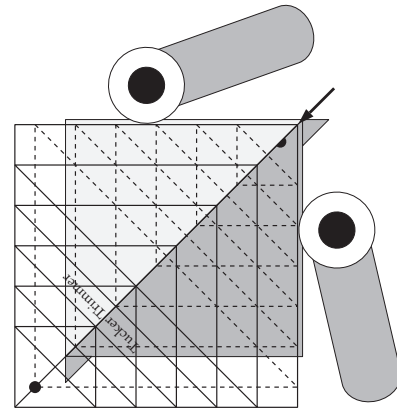

First Trimdown

Rotate the unit and line up the Tucker Trimmer™ again. This time be sure to position the diagonal line and the outline of the square to the measurement desired.

Trim the two remaining sides to create a precise square unit.

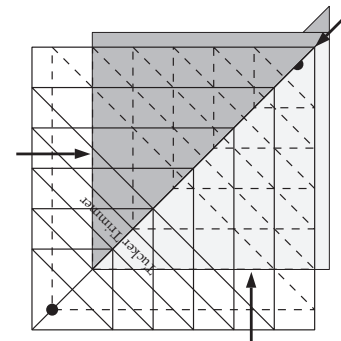

Second Trimdown

For Piecing Combination Units

Determine either the required finished size or cut size of the unit you wish to make. Refer to chart for the suggested size squares to use for making your unit.

Begin with the fabric squares that will become the two smaller, quarter square triangles and proceed as for pieced Half Square Triangle Units: **position, mark, stitch, cut** and **press**. **Don't trim these units down to size yet!**

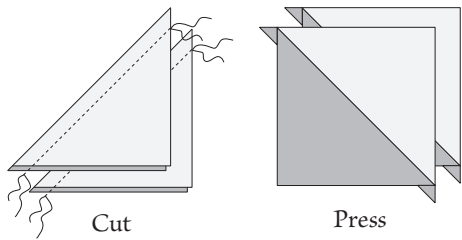
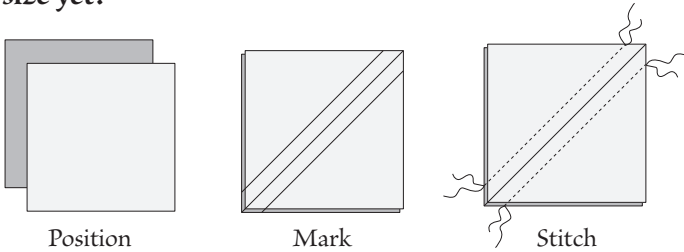

Next **position** a pieced square right sides together with remaining unpieced square.

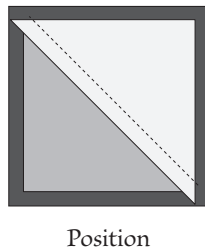

Mark two stitching lines $\frac{1}{4}$ " on either side of a center diagonal line of the pieced square.

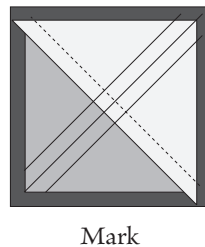

Stitch on lines, then cut down the middle.

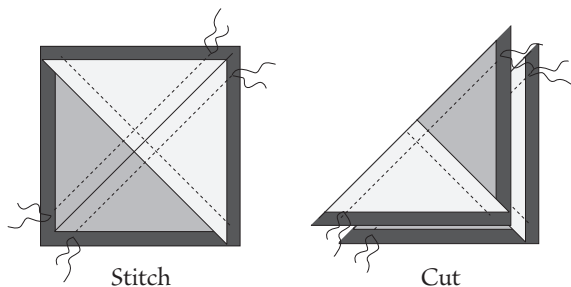

Press seams toward larger triangle.

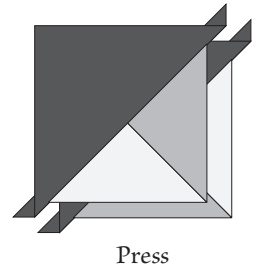

Position the Tucker Trimmer™ over the unit, carefully aligning the common diagonal and the size diagonal with the stitched seams as shown. Note that the right handed quilter will trim up the right side and across the top, while the left handed quilter will trim up the left side and across the top.

Trim one corner (two sides) to a clean edge.

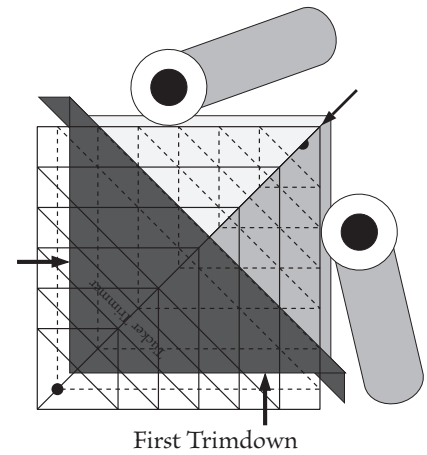

Rotate the unit and line up the Tucker Trimmer™ again. This time be sure to position both diagonal lines and the outline of the square to the exact measurement desired.

Trim the two remaining sides to create a precise square unit.

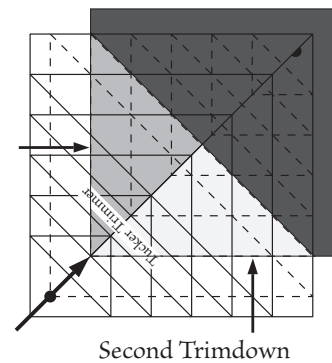

Note: This process creates units that are “mirror images.” Some patterns call for both units in construction, some patterns will use only one direction or the other.

For Piecing Quarter Square Triangles

Determine either the required finished size or cut size of the unit you wish to make. Refer to the chart for the suggested size squares to use for making your unit.

Make half square units as described elsewhere: **position, mark, stitch, cut** and **press**.

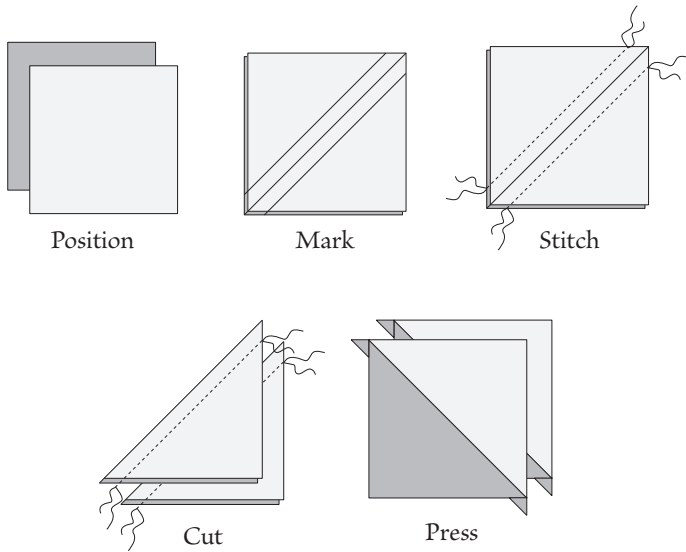

Then **position** pieced units right sides together in pairs. Align the sewn seams.

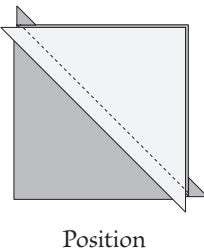

Mark two stitching lines $\frac{1}{4}$ " on either side of a center diagonal line, perpendicular to the already stitched line as shown in the diagram.

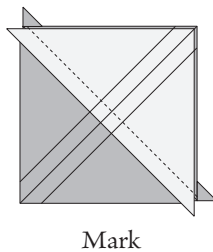

Stitch on lines, **cut** down the middle, then **press** seams.

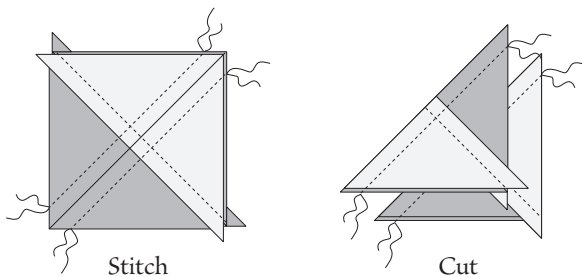

Position Tucker Trimmer™ over pieced square. Carefully align both the common diagonal and the size diagonal over the sewn seam lines of the fabric square.

Trim the side and top to create one clean cut corner.

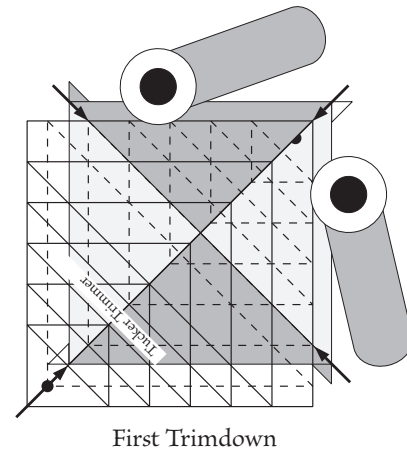

Rotate the pieced unit and line up the Tucker Trimmer™ again. This time be sure to position both the diagonal lines and the outline of the square to the exact measurement desired.

Trim the two remaining sides to create a precise square.

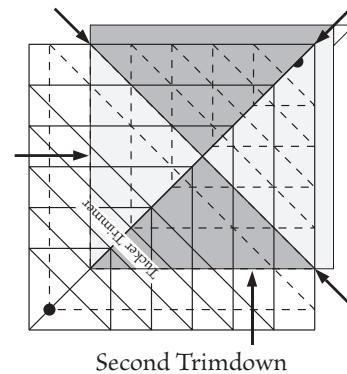

To see other products from Studio 180, such as the other size varieties for the Tucker Trimmer™ or to order the “Quilter’s Magic Wand” companion tool for quickly and easily making those $\frac{1}{4}$ ” seams, contact your local quilt shop or buy directly from Deb Tucker at www.Studio180Design.net.

Star and Square Bonus Pattern

Cutting Instructions:

Dark

- cut 2 squares $4\frac{1}{2}$ "
- cut 1 square $3\frac{1}{2}$ "

Medium

- cut 1 square $4\frac{1}{2}$ "
- cut 4 squares 2"

Light

- cut 1 square $4\frac{1}{2}$ "
- cut 4 rectangles 2 "x $3\frac{1}{2}$ "
- cut 4 squares 2"

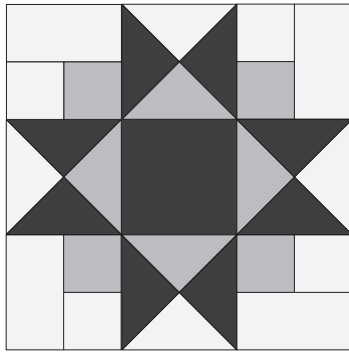

Block Construction:

Step 1: Place one $4\frac{1}{2}$ " dark square right sides together with one $4\frac{1}{2}$ " light square. Place other $4\frac{1}{2}$ " dark square with the $4\frac{1}{2}$ " medium square.

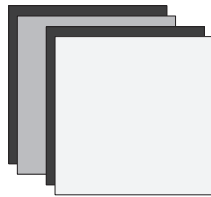

Position

Step 2: Follow directions for making quarter square triangles. Draw two stitching lines, $\frac{1}{4}$ " on both sides of a center diagonal. Stitch on the lines. Cut down the middle. Press all seams toward the dark fabric.

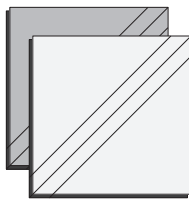

Mark

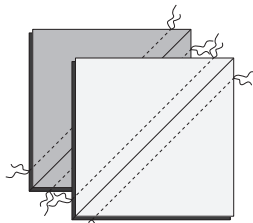

Stitch

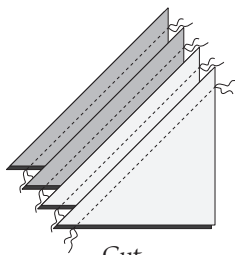

Cut

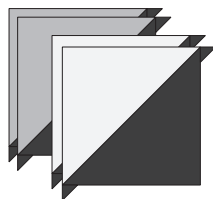

Press

Step 3: Position the pieced squares together. Align a light/dark square with a medium/dark square as illustrated and repeat above procedures — draw, stitch, cut and press.

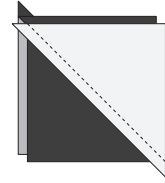

Position

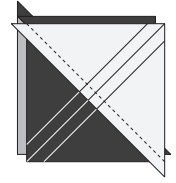

Mark

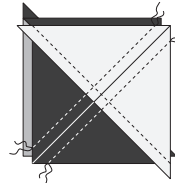

Stitch

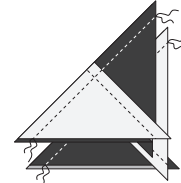

Cut



Press

Step 4: Using the half circle corner of the ruler, trim all squares to exactly $3\frac{1}{2}$ ".

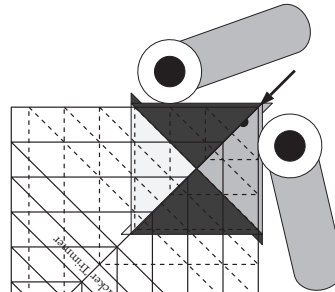

First Trimdown

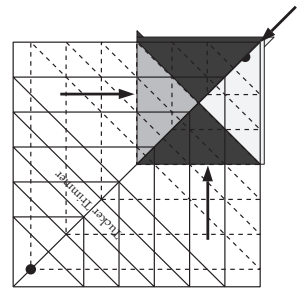

Second Trimdown

Step 5: Sew together the 2" light squares to the 2" medium squares then add the 2 "x $3\frac{1}{2}$ " rectangles as shown. Repeat to make 4 corner units.

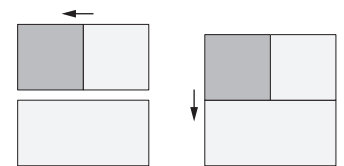

Assemble Squares

Step 6: Lay out block units then stitch together first into rows and then into a complete block.

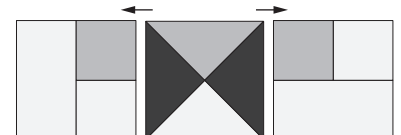
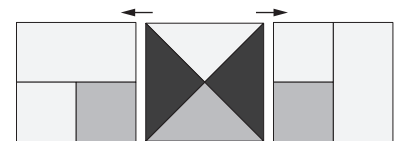

Layout Block